

Battery

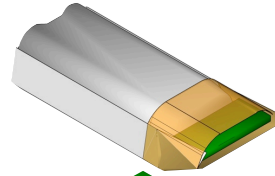

Motor Drivers

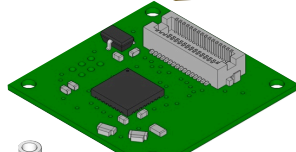

Processor

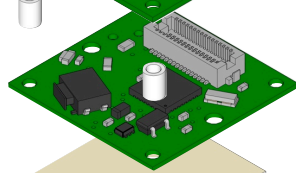

Hall Effect Encoder

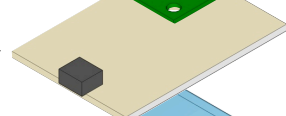

Winch and Spool

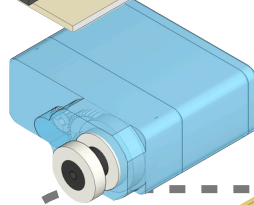

Tow Hook



Drive Motors  
on Lift Arm

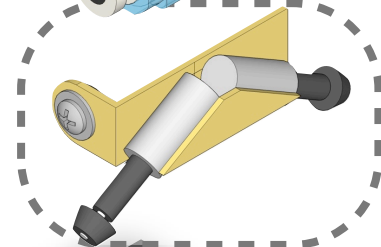

Tow Cable



Tile

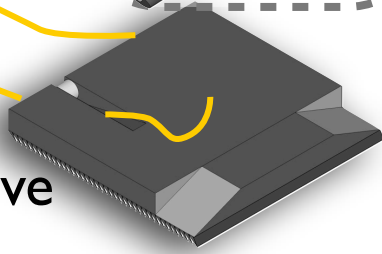

Controllable Adhesive

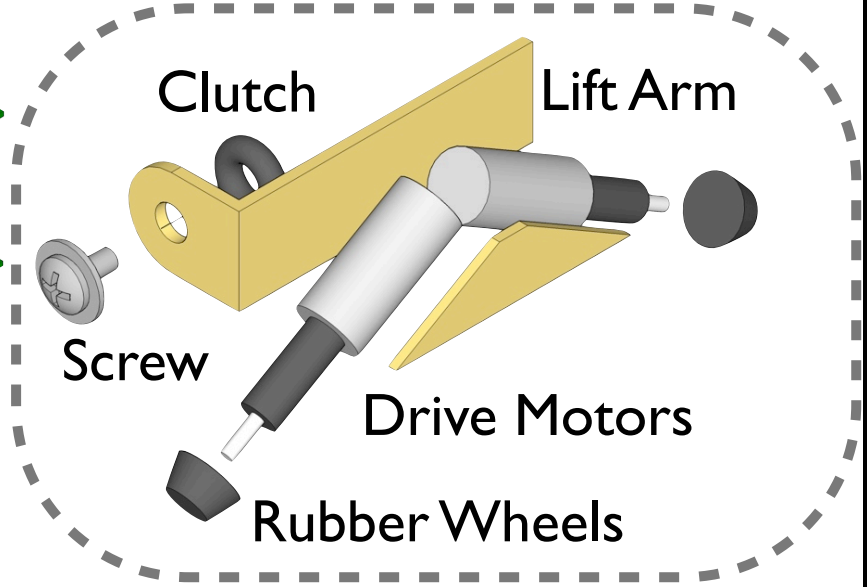

Clutch

Lift Arm

Screw

Drive Motors

Rubber Wheels

